







Display CARFAX in online listings:

		<h1>Vehicle History Report™</h1>		<p>US \$44.99</p>
<p>2010 JEEP PATRIOT SPORT VIN: 1J4NT2GBXAD645565 4 DOOR WAGON/SPORT UTILITY 2.4L I4 F DOHC 16V GASOLINE FRONT WHEEL DRIVE</p>		<p>Accident reported: moderate damage</p> 		
		<p> 20 Service history records</p>		
		<p> 6 Previous owners</p>		
		<p> Personal vehicle</p>		
<p>This CARFAX Report Provided by: Winnipeg Kia</p>		<p> 142,041 Last reported odometer reading</p>		

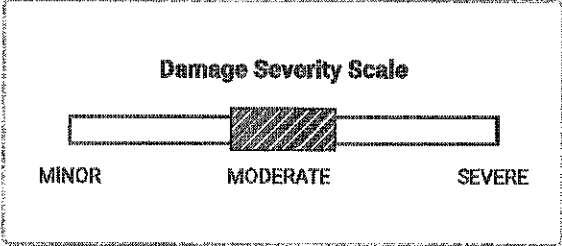
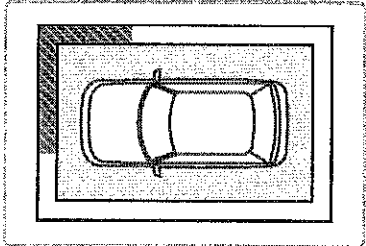

This CARFAX Vehicle History Report is based only on information supplied to CARFAX and available as of 8/13/24 at 12:04:33 PM (CDT). Other information about this vehicle, including problems, may not have been reported to CARFAX. Use this report as one important tool, along with a vehicle inspection and test drive, to make a better decision about your next used car.

		<h2>Accident / Damage History</h2>	
<p>Not all accidents / issues are reported to CARFAX</p>			
<p>Event 1</p>			
<p>04/01/2013 Accident reported: moderate damage - Vehicle involved in a sideswipe collision with another motor vehicle</p>		<p style="text-align: center;">Damage Severity Scale</p> 	
			
<p>Event 2</p>			

07/07/2016
**Accident reported:
 moderate damage with
 another motor vehicle**

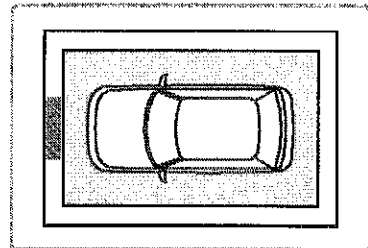
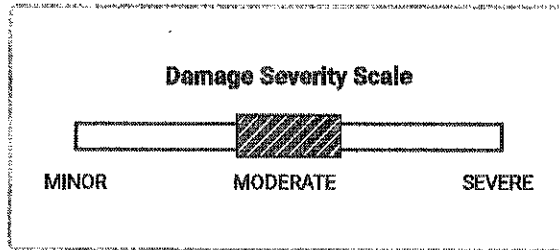

Event 3

07/07/2016
Accident damage claim reported
 - Claim amount was CAD\$2,115
 - Claim amount was updated on 10/08/2016.

CARFAX Additional History Not all accidents / issues are reported to CARFAX	Owners 1-4	Owner 5	Owner 6
Total Loss No total loss reported to CARFAX.	<input type="checkbox"/> No Issues Reported	<input type="checkbox"/> No Issues Reported	<input type="checkbox"/> No Issues Reported
Structural Damage CARFAX recommends that you have this vehicle inspected by a collision repair specialist.	<input type="checkbox"/> No Issues Reported	<input type="checkbox"/> No Issues Reported	<input type="checkbox"/> No Issues Reported
Airbag Deployment No airbag deployment reported to CARFAX.	<input type="checkbox"/> No Issues Reported	<input type="checkbox"/> No Issues Reported	<input type="checkbox"/> No Issues Reported
Odometer Check No indication of an odometer rollback.	<input type="checkbox"/> No Issues Indicated	<input type="checkbox"/> No Issues Indicated	<input type="checkbox"/> No Issues Indicated
Accident / Damage Accidents reported: 04/01/2013 and 07/07/2016.	Accident Reported	No New Issues Reported	No New Issues Reported
Manufacturer Recall No open recalls reported to CARFAX.	<input type="checkbox"/> No Recalls Reported	<input type="checkbox"/> No Recalls Reported	<input type="checkbox"/> No Recalls Reported
Basic Warranty Original warranty estimated to have expired.	Warranty Expired	Warranty Expired	Warranty Expired

CARFAX Title History CARFAX guarantees the information in this section	Owners 1-4	Owner 5	Owner 6
Damage Brands Salvage Junk Rebuilt Fire Flood Hall Lemon	<input checked="" type="checkbox"/> Guaranteed No Problem	<input checked="" type="checkbox"/> Guaranteed No Problem	<input checked="" type="checkbox"/> Guaranteed No Problem

Odometer Brands Not Actual Mileage Exceeds Mechanical Limits	<input checked="" type="checkbox"/> Guaranteed No Problem	<input checked="" type="checkbox"/> Guaranteed No Problem	<input checked="" type="checkbox"/> Guaranteed No Problem
--	--	--	--



GUARANTEED - None of these title problems were reported by a U.S. state Department of Motor Vehicles (DMV). If you find that any of these title problems were reported by a DMV and not included in this report, you may qualify. [View Terms](#) | [View Certificate](#)

Ownership History The number of owners is estimated	Owners 1-4	Owner 5	Owner 6
Year purchased	2010	2022	2024
Type of owner	Personal	Personal	Personal
Estimated length of ownership	12 yrs. 1 mo.	1 yr. 4 mo.	3 months
Owned in the following states/provinces	See Details	Ontario	Ontario
Estimated miles driven per year	See Details	—	—
Last reported odometer reading	124,000	130,667	142,041



Detailed History

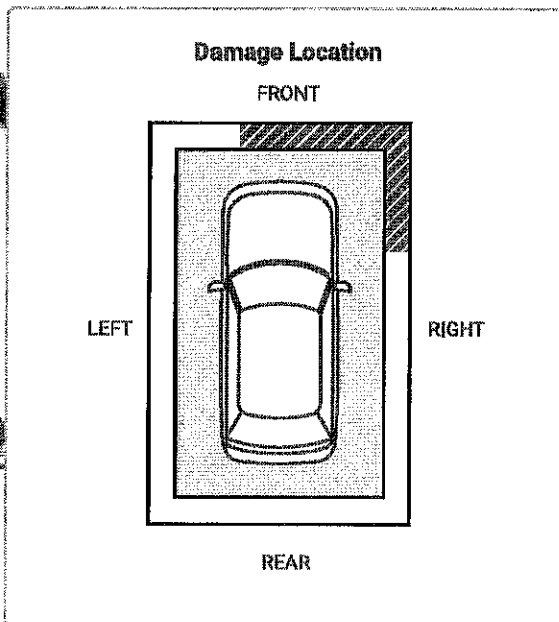
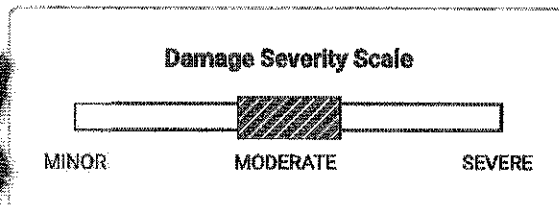

Owner 1 Purchased: 2010		Low mileage! This owner drove less than the industry average of 15,000 miles per year.	Personal Vehicle 11,267 mi/yr
Date	Mileage	Source	Comments
11/09/2010		Ontario Ministry of Transportation	Registration issued or renewed - First owner reported - Passed safety inspection - Vehicle color noted as Green
11/11/2010	7	Bay King Chrysler Hamilton, ON 905-383-7700 baykingmotors.com 1 Customer Favorite	Vehicle serviced - Odometer reported as 11 kilometers
11/26/2010	255	Bay King Chrysler Hamilton, ON 905-383-7700 baykingmotors.com 1 Customer Favorite	Vehicle serviced - Odometer reported as 410 kilometers



02/18/2011	2,765	Bay King Chrysler Hamilton, ON 905-383-7700 baykingmotors.com ♥ 1 Customer Favorite	✂ Vehicle serviced - Odometer reported as 4,450 kilometers
06/14/2011	5,545	Bay King Chrysler Hamilton, ON 905-383-7700 baykingmotors.com ♥ 1 Customer Favorite	✂ Vehicle serviced - Odometer reported as 8,924 kilometers
12/09/2011		Ontario Ministry of Transportation	Registration issued or renewed - Registered as personal vehicle
12/07/2012	24,805	Ontario Ministry of Transportation	Odometer reading reported - Odometer reported as 39,920 kilometers
12/09/2012		Ontario Ministry of Transportation	Registration issued or renewed - Registered as personal vehicle
04/01/2013		Ontario Damage Report	⚠ Accident reported: moderate damage - Vehicle involved in a sideswipe collision with another motor vehicle - Damage to front - Damage to right front



CARFAX HAS THE MOST ACCIDENT & DAMAGE INFORMATION

08/06/2013	30,079	Bay King Chrysler Hamilton, ON 905-383-7700 baykingmotors.com ♥ 1 Customer Favorite	 Vehicle serviced - Odometer reported as 48,407 kilometers
12/05/2014	46,746	Ontario Ministry of Transportation	Odometer reading reported - Odometer reported as 75,230 kilometers
12/09/2014		Ontario Ministry of Transportation	Registration issued or renewed - Registered as personal vehicle
02/10/2015	52,633	Ontario Ministry of Transportation	Registration issued or renewed - Registered as personal vehicle - Odometer reported as 84,705 kilometers
07/13/2015	52,693	Eastgate Ford Hamilton, ON 905-547-3211 eastgateford.com	 Vehicle serviced - Emissions inspection performed - Odometer reported as 84,801 kilometers

 Owner 2 Purchased: 2015		Low mileage! This owner drove less than the industry average of 15,000 miles per year.	Personal Vehicle 9,525 mi/yr
--	--	---	--

Date	Mileage	Source	Comments
07/17/2015		Ontario Ministry of Transportation	Passed Ontario safety standards inspection - New owner reported
07/20/2015		Service Facility Hamilton, ON	 Vehicle serviced - Pre-delivery inspection completed - Recommended maintenance performed - Nitrogen fill tires - Brake drum(s) resurfaced - Brake shoes replaced - Rear brake shoes replaced - Front brakes serviced - Emissions inspection performed
07/28/2015		Ontario Service Facility	Mechanical issue reported - Vehicle towed
07/07/2016		Ontario Damage Report	 Accident reported: moderate damage with another motor vehicle - Damage to front

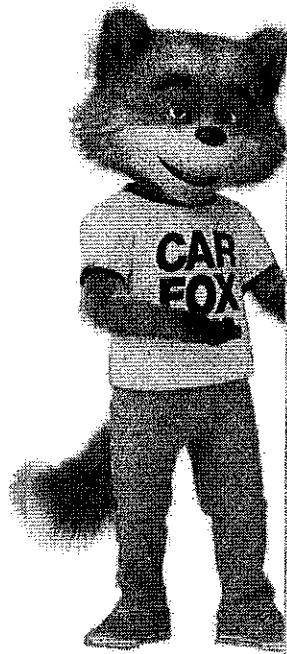

CARFAX HAS THE MOST ACCIDENT & DAMAGE INFORMATION

Damage Severity Scale



Damage Location

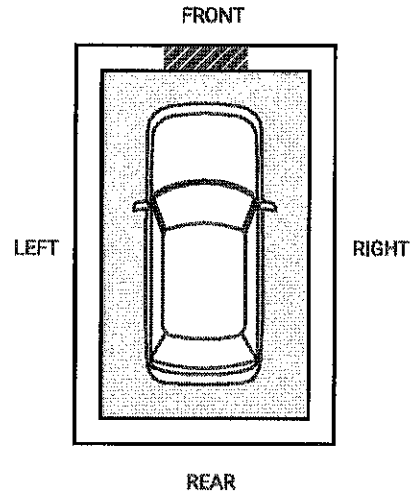

07/07/2016	Damage Report Ontario		Accident damage claim reported - Claim amount was CAD\$2,115 - Claim amount was updated on 10/08/2016.
11/07/2016 72,458	Jiffy Lube Hamilton, ON 905-389-6100 jiffylube.ca ★ 4.7 / 5.0 12 Verified Reviews ♥ 26 Customer Favorites		Vehicle serviced - Oil and filter changed - Air filter replaced - Cabin air filter replaced/cleaned - Odometer reported as 116,610 kilometers
02/10/2017	Ontario Ministry of Transportation		Registration issued or renewed - Registered as personal vehicle
05/07/2019 98,339	Ontario Ministry of Transportation		Registration issued or renewed - Registered as personal vehicle - Odometer reported as 158,261 kilometers
05/16/2019 98,574	Lube-A-Car Hamilton, ON 905-521-8883 lube-a-car.ca/ ★ 4.3 / 5.0 10 Verified Reviews ♥ 5 Customer Favorites		Vehicle serviced - Oil and filter changed - Odometer reported as 158,639 kilometers

05/22/2019	98,764	Zellens Auto Mall Hamilton, ON 905-777-8030 ♥ 10 Customer Favorites	✕	Vehicle serviced - Throttle body cleaned/serviced - Air filter replaced - Spark plug(s) replaced - Rear brakes serviced/adjusted - Odometer reported as 158,945 kilometers
06/14/2019	99,612	Zellens Auto Mall Hamilton, ON 905-777-8030 ♥ 10 Customer Favorites	✕	Vehicle serviced - Odometer reported as 160,310 kilometers
07/30/2019	101,258	Zellens Auto Mall Hamilton, ON 905-777-8030 ♥ 10 Customer Favorites	✕	Vehicle serviced - Front brakes serviced - Brake pads replaced - Front brake pads replaced - Wheel bearings repacked - Front brake rotor(s) replaced - Odometer reported as 162,959 kilometers
06/19/2020	108,636	Zellens Auto Mall Hamilton, ON 905-777-8030 ♥ 10 Customer Favorites	✕	Vehicle serviced - Oil and filter changed - Maintenance reminder reset - Fluids checked - Tire condition and pressure checked - Odometer reported as 174,833 kilometers
06/30/2020	108,931	S & W Service Centre St. Catharines, ON 905-935-9971 swservicecentre.ca/ ♥ 5 Customer Favorites	✕	Vehicle serviced
10/16/2020	111,967	Lube-A-Car Hamilton, ON 905-521-8883 lube-a-car.ca/ ★ 4.3 / 5.0 10 Verified Reviews ♥ 5 Customer Favorites	✕	Vehicle serviced - Oil and filter changed - Odometer reported as 180,193 kilometers
02/22/2021	113,659	Ontario Ministry of Transportation		Registration issued or renewed - Registered as personal vehicle - Odometer reported as 182,916 kilometers
06/08/2021	115,322	Lube-A-Car Hamilton, ON 905-521-8883 lube-a-car.ca/	✕	Vehicle serviced - Oil and filter changed - Odometer reported as 185,593 kilometers

★ 4.3 / 5.0
 10 Verified Reviews
 ♥ 5 Customer Favorites

09/22/2021	118,169	Lube-A-Car Hamilton, ON 905-521-8883 lube-a-car.ca/ ★ 4.3 / 5.0 10 Verified Reviews ♥ 5 Customer Favorites	✕ Vehicle serviced - Oil and filter changed - Odometer reported as 190,175 kilometers
------------	---------	--	--

11/24/2021	120,446	Zellens Auto Mall Hamilton, ON 905-777-8030 ♥ 10 Customer Favorites	✕ Vehicle serviced - Tire(s) replaced - Tire(s) mounted - Tire condition and pressure checked - Steering/suspension lubricated - Tires rotated - Odometer reported as 193,839 kilometers
------------	---------	--	---

03/08/2022	123,264	Lube-A-Car Hamilton, ON 905-521-8883 lube-a-car.ca/ ★ 4.3 / 5.0 10 Verified Reviews ♥ 5 Customer Favorites	✕ Vehicle serviced - Oil and filter changed - Odometer reported as 198,374 kilometers
------------	---------	--	--

04/05/2022	124,000	Zellens Auto Mall Hamilton, ON 905-777-8030 ♥ 10 Customer Favorites	✕ Vehicle serviced - Starter replaced - Odometer reported as 199,559 kilometers
------------	---------	--	--

Owner 3 Personal Vehicle
 Purchased: 2022

Date	Mileage	Source	Comments
10/21/2022		Ontario Ministry of Transportation	Passed Ontario safety standards inspection - New owner reported - Vehicle color noted as Green

Owner 4 Personal Vehicle
 Purchased: 2022

Date	Mileage	Source	Comments
11/10/2022		Ontario	Passed Ontario safety standards inspection

Ministry of
Transportation

- New owner reported
- Vehicle color noted as Green



Owner 5
Purchased: 2022

Personal Vehicle

Date	Mileage	Source	Comments
12/22/2022	130,667	Ontario Ministry of Transportation	Passed Ontario safety standards inspection - Registration issued or renewed - New owner reported - Registered as personal vehicle - Vehicle color noted as Green - Odometer reported as 210,288 kilometers



Owner 6
Purchased: 2024

Personal Vehicle

Date	Mileage	Source	Comments
05/10/2024	142,041	Ontario Ministry of Transportation Kitchener/Waterloo, ON	Passed Ontario safety standards inspection - Registration issued or renewed - New owner reported - Registered as personal vehicle - Vehicle color noted as Green - Odometer reported as 228,593 kilometers

Have Questions? Consumers, please visit our Help Center at www.carfax.com. Dealers or Subscribers, please visit our Help Center at www.carfaxonline.com.



Glossary

Accident Indicator

CARFAX receives information about accidents in all 50 states, the District of Columbia and Canada.

Not every accident is reported to CARFAX. As details about the accident become available, those additional details are added to the CARFAX Vehicle History Report. CARFAX recommends that you have this vehicle inspected by a qualified mechanic.

- According to the National Safety Council, Injury Facts, 2021 edition, 5% of the 276 million registered vehicles in the U.S. were involved in an accident in 2019. Over 77% of these were considered minor or moderate.
- This CARFAX Vehicle History Report is based only on information supplied to CARFAX and available as of 8/13/24 at 12:04:33 PM (CDT). Other information about this vehicle, including problems, may not have been reported to CARFAX. Use this report as one important tool, along with a vehicle inspection and test drive, to make a better decision about your next used car.

Canadian Damage Report

CARFAX receives damage reports for many accidents occurring in the following Canadian Provinces: Ontario, Alberta, Nova Scotia, New Brunswick, Prince Edward Island, Newfoundland, Yukon territories, Northwest territories,

and Nunavut. These reports may be completed following an accident or other incident. Some include a damage claim amount. This amount represents physical damage to the vehicle and depending on the accident, damage to other vehicles and/or property. It does not include expenses like towing, a rental car or any medical related items.

Damage Severity

Damage events result in one of the following severity levels:

- **Minor:** Generally, minor damage is cosmetic (including dents or scratches), may only require reconditioning, and typically does not compromise a vehicle's operation and/or safety.
- **Moderate:** Moderate damage may affect multiple components of the vehicle and may impair the vehicle's operation and/or safety.
- **Severe:** Severe damage usually affects multiple components of the vehicle and is likely to compromise the vehicle's operation and/or safety.

CARFAX recommends getting a pre-purchase inspection at a certified collision repair facility.

First Owner

When the first owner(s) obtains a title from a Department of Motor Vehicles as proof of ownership.

New Owner Reported

When a vehicle is sold to a new owner, the Title must be transferred to the new owner(s) at a Department of Motor Vehicles.

Ownership History

CARFAX defines an owner as an individual or business that possesses and uses a vehicle. Not all title transactions represent changes in ownership. To provide estimated number of owners, CARFAX proprietary technology analyzes all the events in a vehicle history. Estimated ownership is available for vehicles manufactured after 1991 and titled solely in the US including Puerto Rico. Dealers sometimes opt to take ownership of a vehicle and are required to in the following states: Maine, Massachusetts, New Jersey, Ohio, Oklahoma, Pennsylvania and South Dakota. Please consider this as you review a vehicle's estimated ownership history.

Follow Us:  facebook.com/CARFAX  [@CARFAXinc](https://twitter.com/CARFAXinc)  [About CARFAX](#)

CARFAX DEPENDS ON ITS SOURCES FOR THE ACCURACY AND RELIABILITY OF ITS INFORMATION. THEREFORE, NO RESPONSIBILITY IS ASSUMED BY CARFAX OR ITS AGENTS FOR ERRORS OR OMISSIONS IN THIS REPORT. CARFAX FURTHER EXPRESSLY DISCLAIMS ALL WARRANTIES, EXPRESS OR IMPLIED, INCLUDING ANY IMPLIED WARRANTIES OF MERCHANTABILITY OR FITNESS FOR A PARTICULAR PURPOSE.

© 2024 CARFAX, Inc., part of S&P Global. All rights reserved.
8/13/24 12:04:33 PM (CDT)

I have reviewed and received a copy of the CARFAX Vehicle History Report for this 2010 JEEP PATRIOT vehicle (VIN: 1J4NT2GBXAD645565), which is based on information supplied to CARFAX and available as of 8/13/24 at 1:04 PM (EDT).

Customer Signature

Date

Dealer Signature

Date